

PLAN

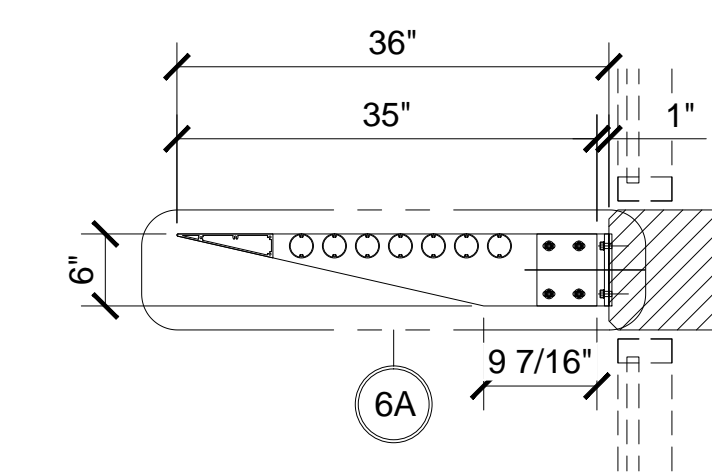
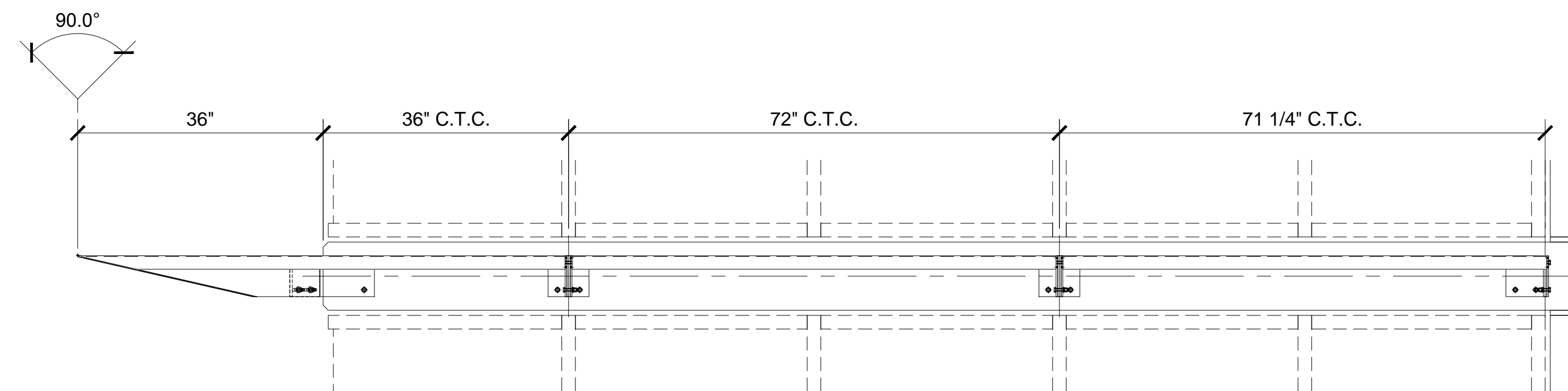
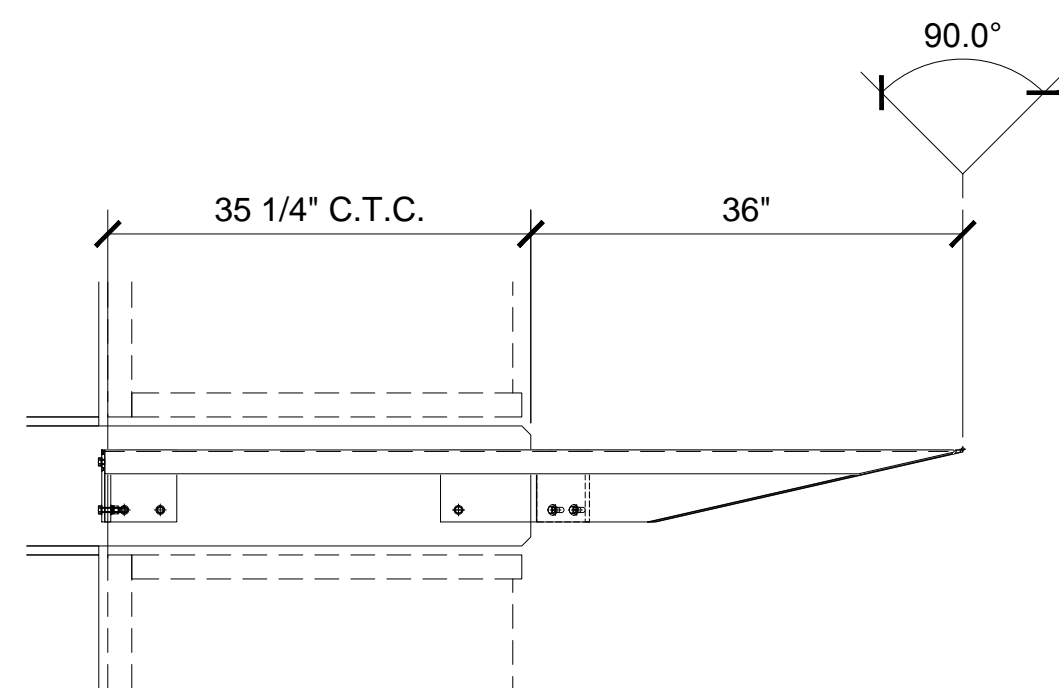

ELEVATIONS

SECTION

CRL US ALUMINUM SUNSHADE SYSTEM 1600 SERIES

6" TAPERED NOSE OUTRIGGER WITH TAPERED NOSE FASCIA AND 2" ROUND INFILL BLADES

OUTRIGGER

- 9 STANDARD OUTRIGGER STYLES
- *OUTRIGGERS AVAILABLE IN FIVE STANDARD NOMINAL LENGTHS: 24", 30", 36", 42" AND 48"
- * CUSTOM HEIGHTS AND LENGTHS ARE AVAILABLE
- * CUSTOM CORNER OUTRIGGER ARE AVAILABLE

FINISHES

- 5 STANDARD FINISHES:
 - * MILL
 - * SATIN ANODIZED
 - * DARK BRONZE ANODIZED
 - * POWDER COAT
 - * KYNAR PAINT

MOUNTING BRACKET

- * 5 DIFFERENT MOUNTING OPTIONS
- WALL MOUNT BRACKET
- UNIVERSAL CURTAIN WALL MOUNT
- CURTAIN WALL MOUNT (MULLION WEB MOUNT)
- STRUCTURAL SILICONE CURTAIN WALL MOUNT
- STOREFRONT SURFACE MOUNT
- * CUSTOM MOUNTING BRACKETS ARE AVAILABLE
- * CUSTOM CORNER MOUNTING BRACKETS ARE AVAILABLE

FASCIA

- * 14 DIFFERENT FASCIA OPTIONS
- SQUARE TUBE FASCIA (2 STD. SIZES)
- "C" CHANNEL FASCIA (2 STD. SIZES)
- ROUND TUBE FASCIA (2 STD. SIZES)
- BULLNOSE FASCIA (2 STD. SIZES)
- 6" BULLNOSE
- 12" BULLNOSE
- TAPERED NOSE FASCIA
- TEAR DROP TWO-PIECE FASCIA
- SQUARE TWO-PIECE FASCIA
- ROUND TWO-PIECE FASCIA

INFILL BLADES

- * 37 DIFFERENT INFILL BLADE OPTIONS
- AIR FOIL BLADES (5 STD. SIZES)
- ROUND TUBE BLADES (5 STD. SIZES)
- SQUARE TUBE BLADES (5 STD. SIZES)
- RECTANGULAR TUBE BLADES (5 STD. SIZES)
- FLAT BAR EXTRUDED BLADES (12 STD. SIZES)
- 1/8" THICK BLADES (5 SIZES)
- 1/4" THICK BLADES (7 SIZES)
- "C", "S" AND "Z", EXTRUDED BLADES
- "C" SHAPED BLADES (1 SIZE)
- "S" SHAPED BLADES (2 SIZES)
- "Z" SHAPED BLADES (2 SIZES)

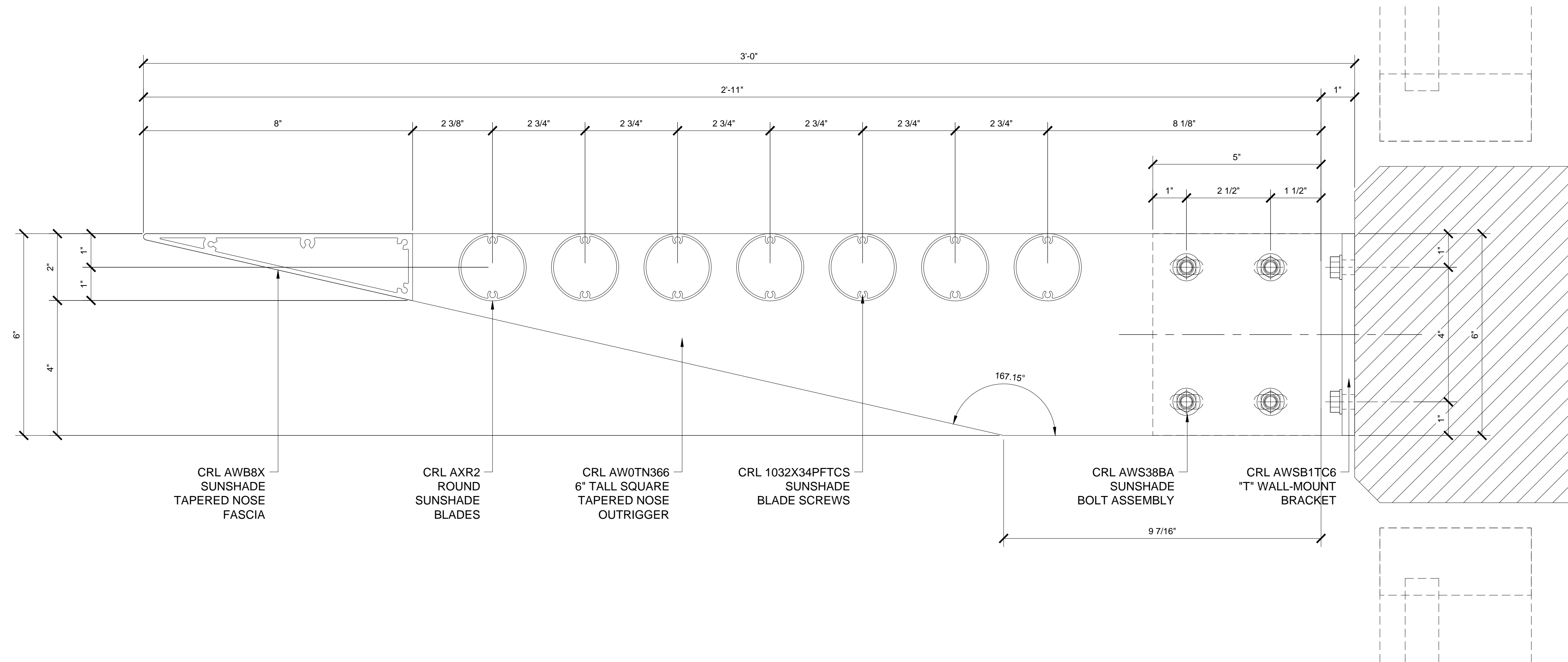

Description:
 CRL U.S. ALUMINUM
 ARCHITECTURAL
 SUNSHADE SYSTEMS
 SERIES 1600

Drawn By: VM
 Date: 01/17/14
 Scale: 6" = 1'-0"
 File Name: CRLUSAL SS 1600.dwg

Sheet
6A

CRL 36" SUNSHADE SECTION DETAIL
 4" TALL SQUARE OUTRIGGER WITH 1X4" RECTANGULAR FASCIA AND INFILL BLADES

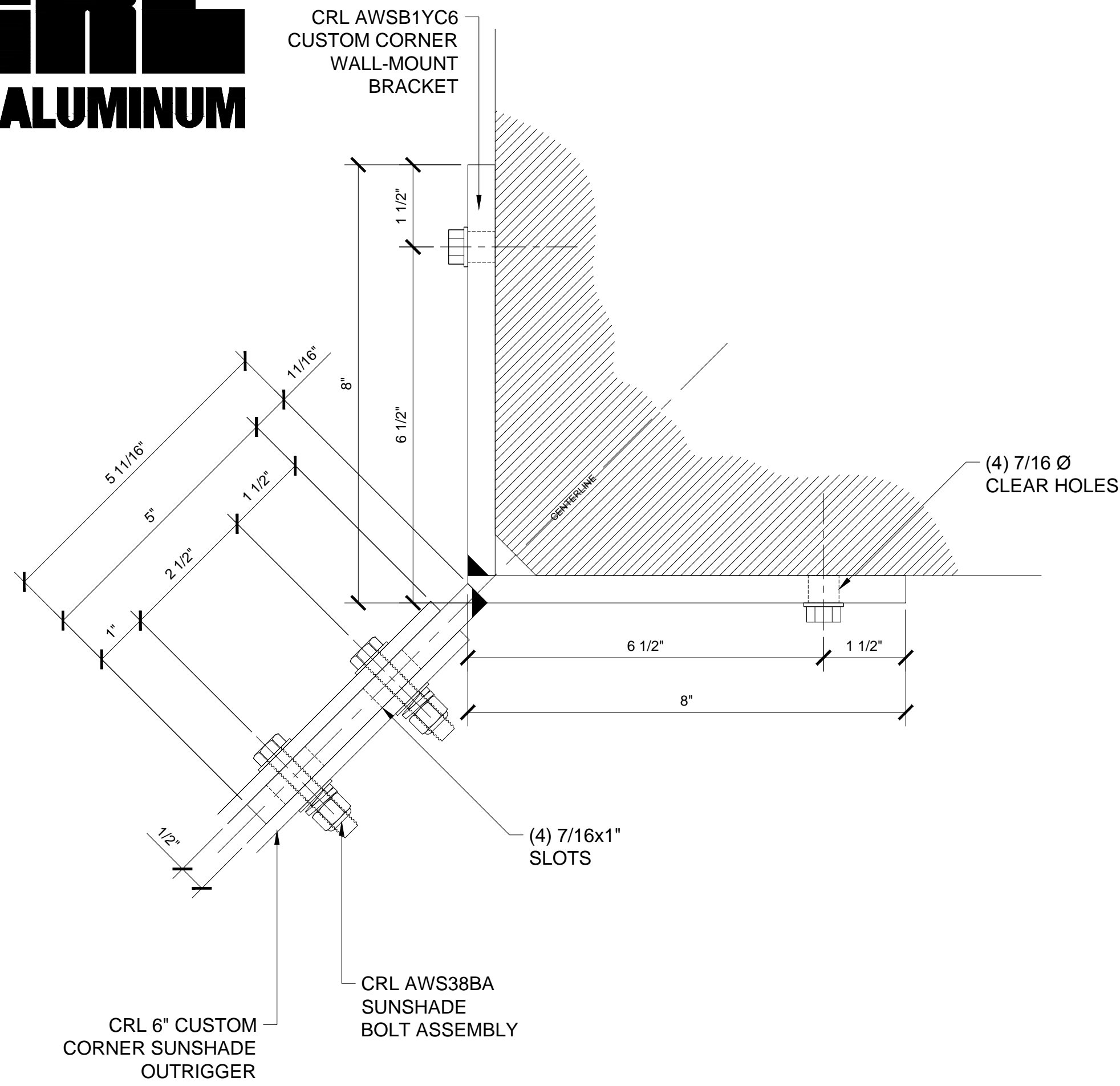

TYPICAL CORNER 6" BRACKET DETAILS
CRL AWSB1YC6 CUSTOM CORNER WALL MOUNT BRACKET

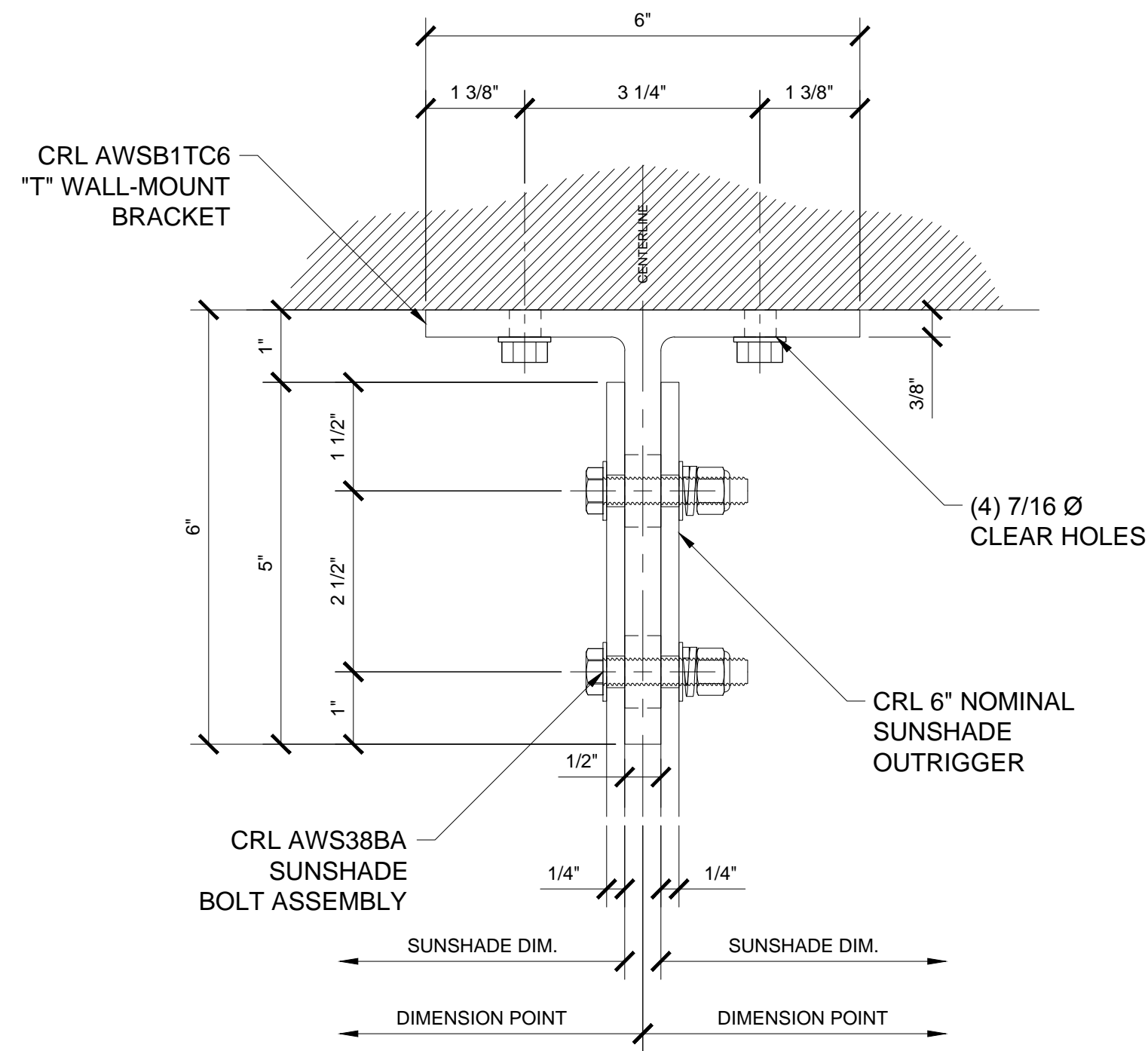

TYPICAL INTERMEDIATE 6" BRACKET DETAILS
CRL AWSB1TC6 "T" WALL MOUNT BRACKET

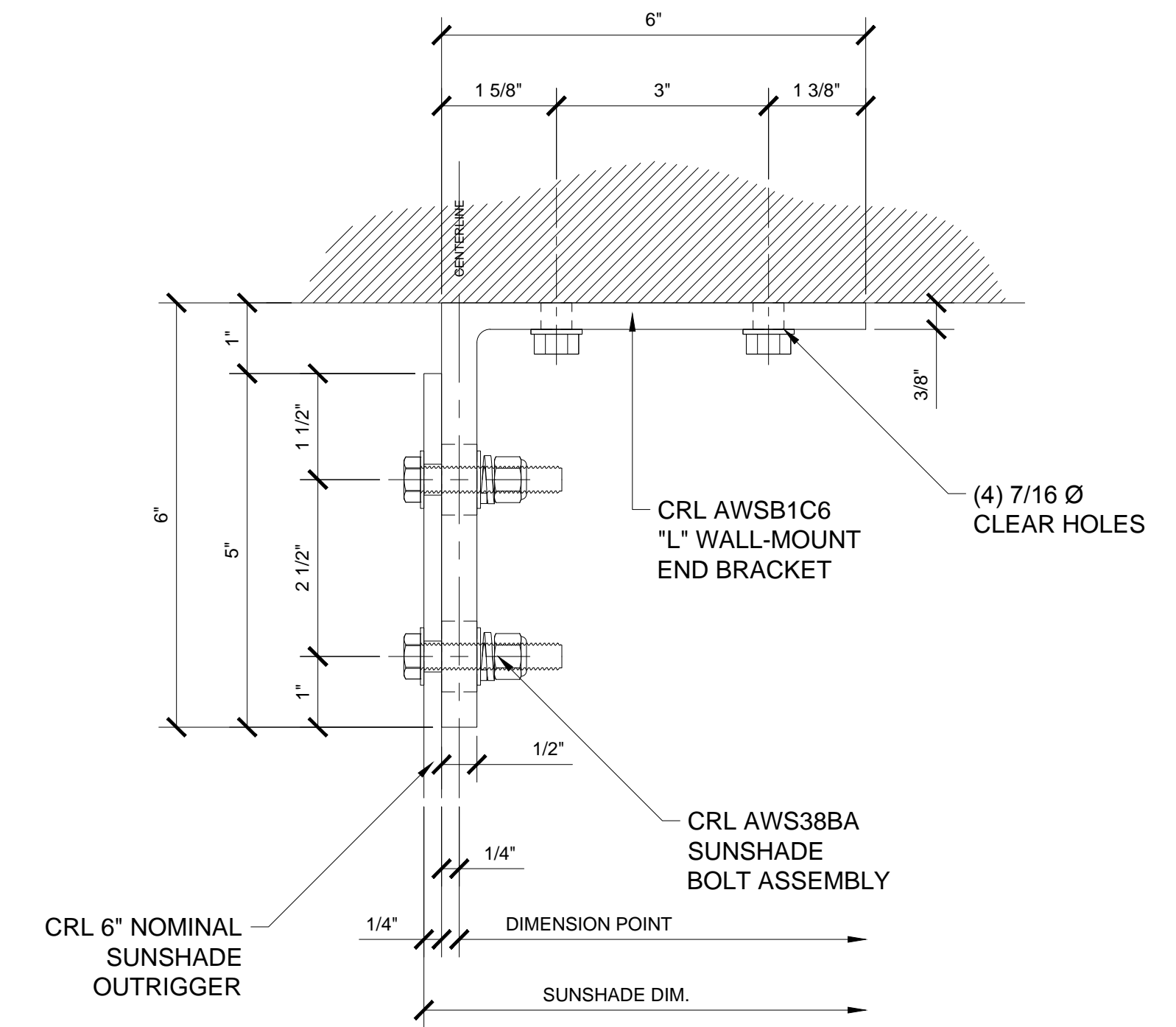

TYPICAL END 6" BRACKET DETAILS
CRL AWSB1C6 "L" WALL MOUNT END BRACKET

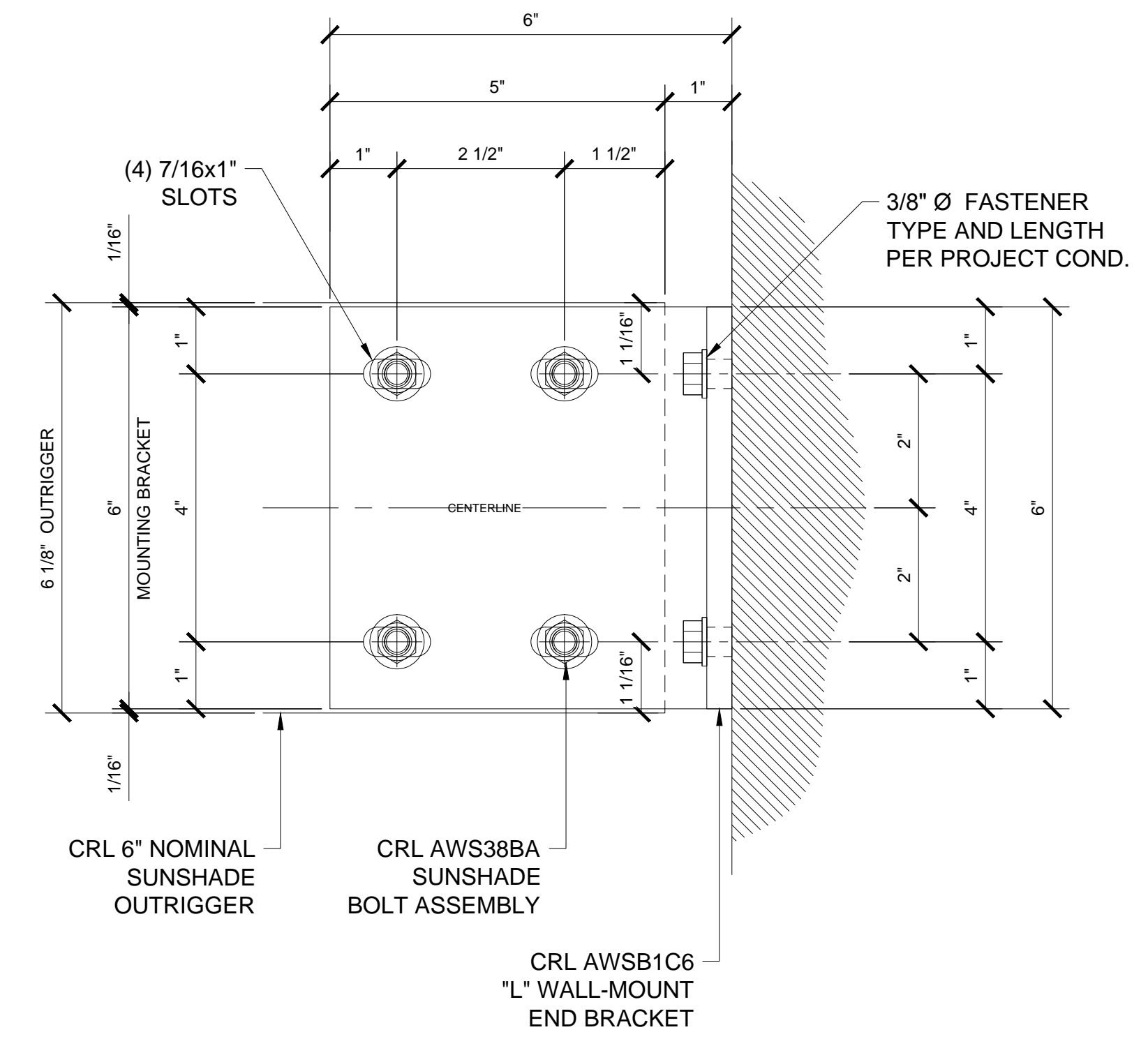
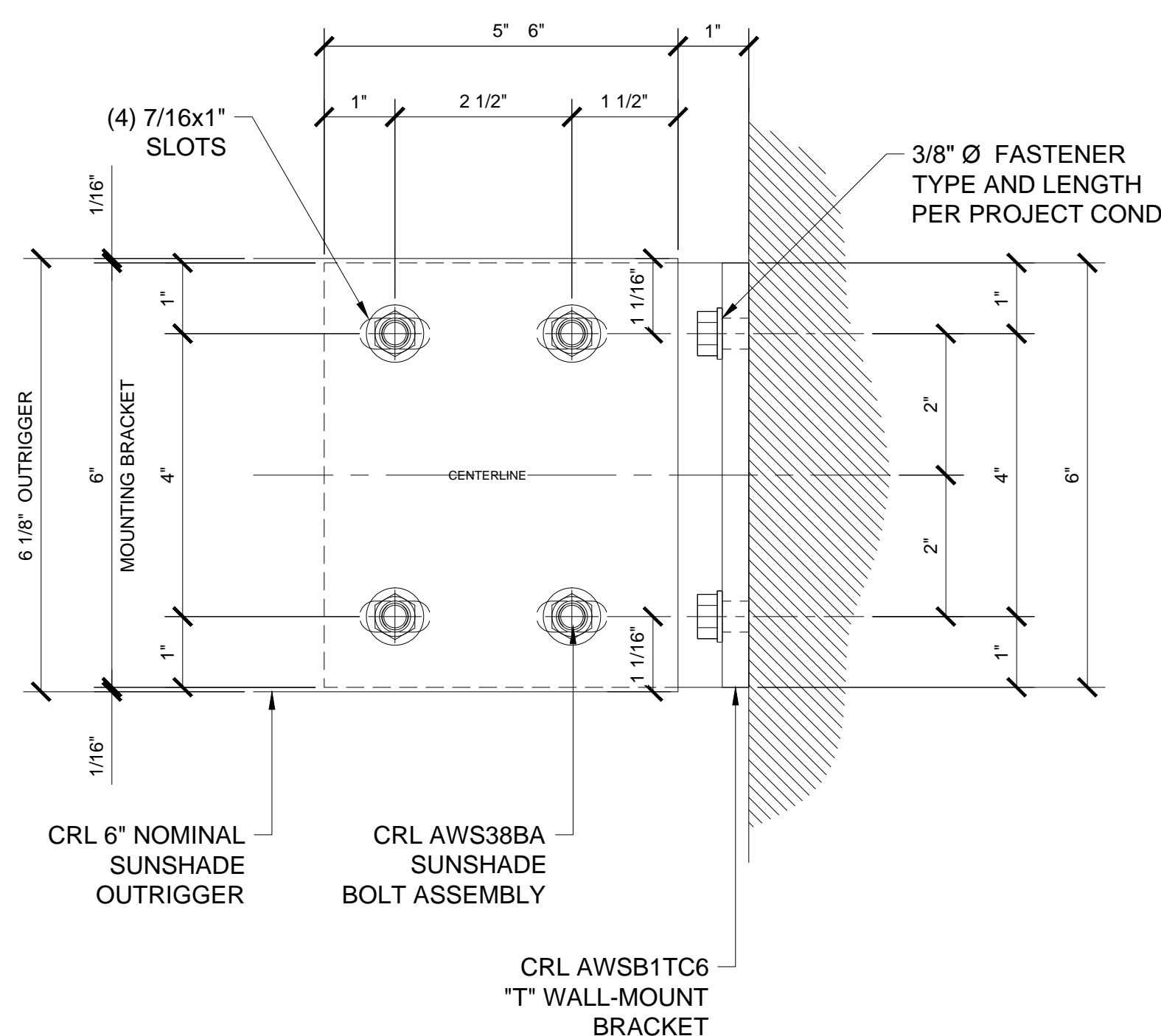
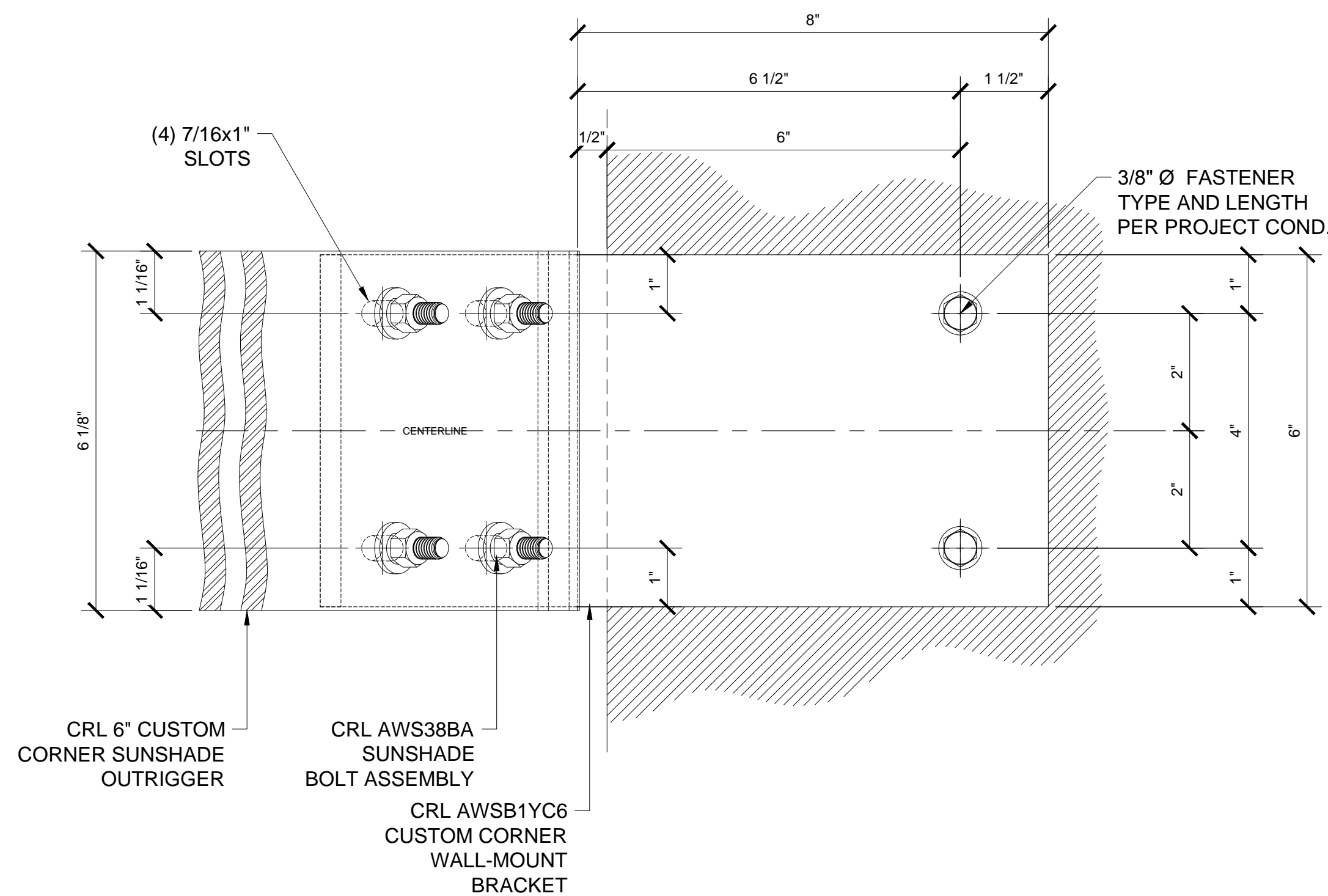

Revisions By:

Discription:
CRL U.S. ALUMINUM
ARCHITECTURAL
SUNSHADE SYSTEMS
SERIES 1600

Drawn By: VM
Date: 01/17/14
Scale: 6" = 1'-0"
File Name: CRLUSAL SS 1600.dwg

Sheet