

PANIC DEVICES

- Concealed Vertical Rod Panics**
- Jackson 1285
 - Jackson 2086
 - Jackson 1085
 - Adams-Rite 8600
 - With Cylinder on Active Leaf
 - Exit Only
 - With Cylinders on Pair (Both Leaf's)

- Rim Panics**
- Jackson 1295
 - Jackson 2095
 - Jackson 1095
 - Adams-Rite 8800
 - With Cylinder on Active Leaf
 - Exit Only
 - Removable Mullion (For Pair of Doors)
 - With Cylinders on Pair (Both Leaf's)

- Mortise Panics**
- Adams-Rite 8400
 - CRL-Blumcraft Panic
 - Custom By USALUM By Customer
 - Prep and Supply Prep Only

NOTE: Prep Only Requires Manufacturer's Name , Model, and Template

Manufacturer: _____

Model: _____

FRAME SYSTEM

- Series 400** 1-3/4" x 4" Tubular Open Back
- Series 450** 1-3/4" x 4-1/2" Tubular Open Back
- Series 451** 2" x 4-1/2" Tubular Open Back
- Flush Front** 4-1/2" FF450 FF451
- Flush Front** 6" FF600 FF601
- Subframe** 1" x 4-1/2"
- Custom: Specify _____

FRAME TYPE

- Up and Over (No Transom)
- 126" (3.2 m) High With Transom
- Frame Only
- Door Only (No Frame)
- Custom

PUSH/PULL HARDWARE

- Standard Push Bars
 - Standard Push/Pull
 - Offset Pulls
 - None
 - Custom By USALUM By Customer
 - Prep and Supply Prep Only
- NOTE:** Prep Only Requires Manufacturer's Name , Model, and Template
- Manufacturer: _____
- Model: _____

DOOR SWING CHART

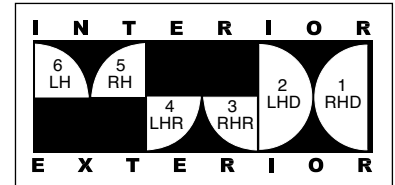

Use the Door Swing Chart to determine how the door(s) should be handed.

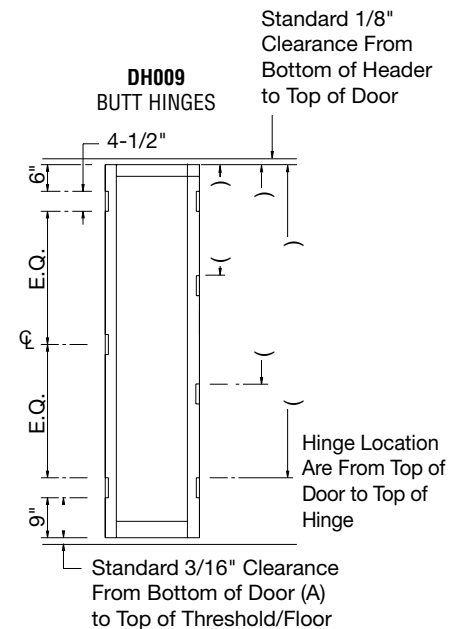
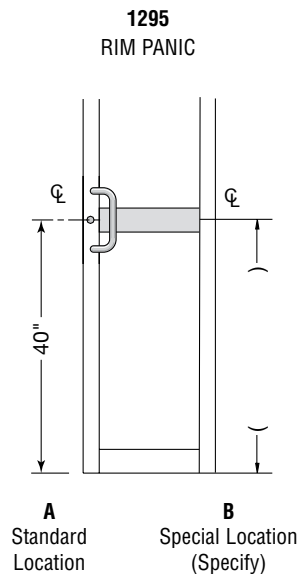
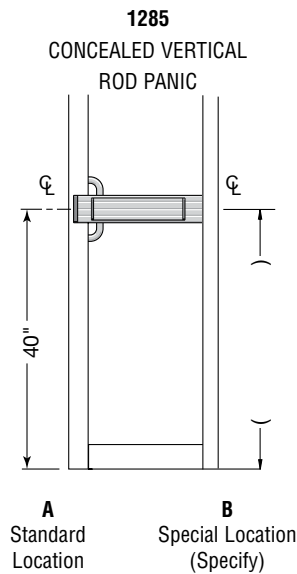
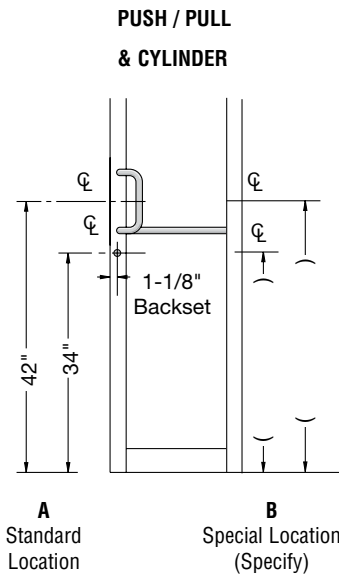

FOR OFFICE USE ONLY

TAKEN BY: _____

PRICED BY: _____

EDITED BY: _____

APPROVED _____

DATE _____

VISION LITE GLASS STOP

- With 1/4" Square Glass Stops
- With 1/4" Bevel Glass Stops
- With 1" Glass Stops
- Other _____

LOWER HALF PANEL MUNTIN OPTIONS

- 5/8" 5" 7-1/2"
- 2" 6-3/16" 9-1/2"
- 4-1/8" 6-1/2" Custom

* Dimensions do not include stops.

DIMENSIONS	ACTIVE DOOR	INACTIVE DOOR
D1		
D2		
D3		
D4		

NOTE: For Painted Doors Consult Factory Prior to Application

FLUSH PANEL CONFIGURATIONS

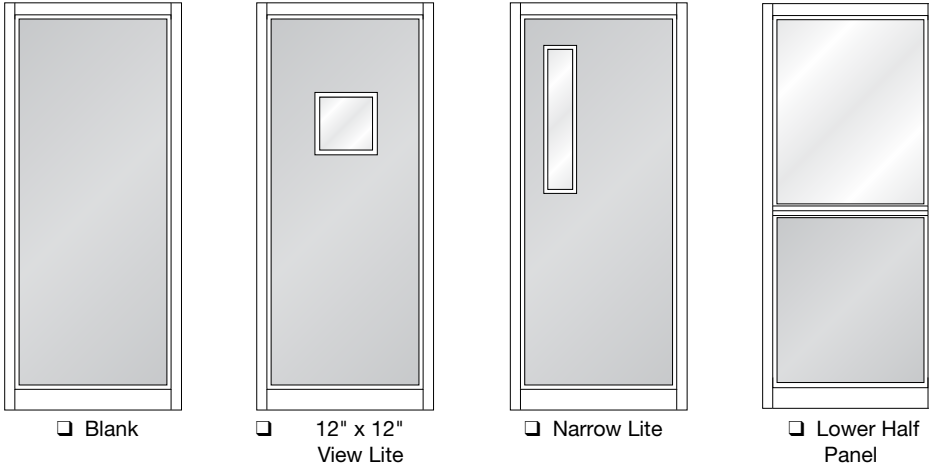

CUSTOM (PLEASE SKETCH)

APPROVED _____

DATE _____

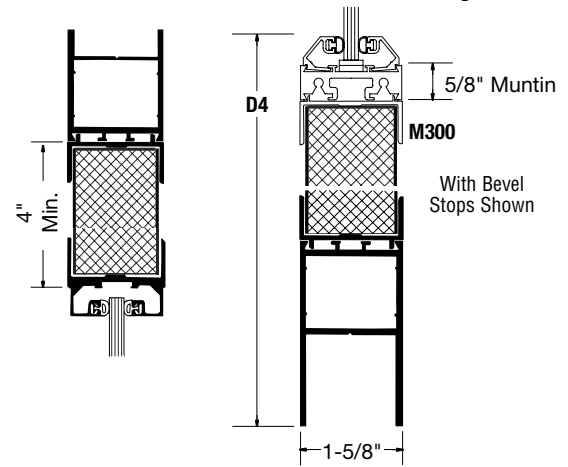
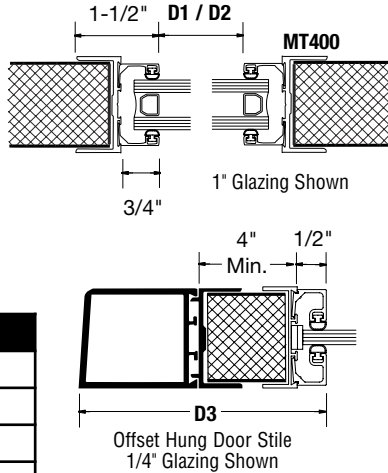

FLUSH PANEL WITH VISION LITE DIMENSIONS

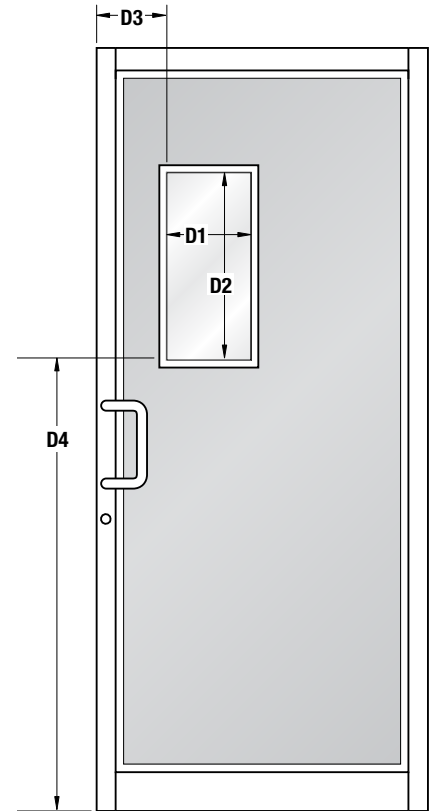

Series 1000 Flush Panel
250 Narrow Stile
Offset Hung (Exterior View)

FOR OFFICE USE ONLY

TAKEN BY: _____

PRICED BY: _____

EDITED BY: _____